

Canon

PRIMA

AF-8

PRIMA

AF-8

DATE



**E** English

**C** 中國語

**M** Bahasa Malaysia

**K** 한국어

## **E** Handling Precautions

1. This camera is not resistant to water, and should not be used outdoors if it is raining or snowing. If it is accidentally dropped in water, contact an authorized Canon service facility. Keep the camera out of salt spray and excessive humidity. If used at the beach, clean it thoroughly afterward with a dry cloth.
2. Store the camera in a cool, dry, dust-free place. Be sure to keep the camera out of direct sunlight, and away from "hot spots" such as the trunk or rear window shelf of a car. Avoid places where mothballs are used, and use a desiccant in excessive humidity.
3. Do not attempt to disassemble the camera yourself, since there is high-voltage circuitry inside.
4. The battery may explode or cause burns if disassembled, recharged, shorted, exposed to high temperatures, or disposed of in a fire.
5. Use a blower brush to remove dust and sand from the lens and inside the camera. Do not apply any fluids to the lens or body. Take the camera to an authorized Canon service facility for a more thorough cleaning if necessary.
6. Film passing through X-ray examinations at an airport may be exposed and ruined even when loaded in the camera. Request a different method of inspection to avoid damage.
7. Color reproduction may be adversely affected if the film is left in the camera for a long time. Always develop exposed film promptly.

 The CE Mark is a Directive conformity mark of the European Community (EC).

This device complies with Part 15 of the FCC Rules. Operation is subject to the following two conditions: (1) This device may not cause harmful interference, and (2) this device must accept any interference received, including interference that may cause undesired operation.

Do not make any changes or modifications to the equipment unless otherwise specified in the instructions. If such changes or modifications should be made, you could be required to stop operation of the equipment.

This equipment has been tested and found to comply with the limits for a class B digital device, pursuant to part 15 of the FCC Rules. These limits are designed to provide reasonable protection against harmful interference in a residential installation. This equipment generates, uses and can radiate radio frequency energy and, if not installed and used in accordance with the instructions, may cause harmful interference to radio communications.

However, there is no guarantee that interference will not occur in a particular installation. If this equipment does cause harmful interference to radio or television reception, which can be determined by turning the equipment off and on, the user is encouraged to try to correct the interference by one or more of the following measures:

- Reorient or relocate the receiving antenna.
- Increase the separation between the equipment and receiver.
- Consult the dealer or an experienced radio/TV technician for help.

---

This digital apparatus does not exceed the Class B limits for radio noise emissions from digital apparatus as set out in the interference-causing equipment standard entitled "Digital Apparatus", ICES-003 of the Industry Canada.

---

Cet appareil numérique respecte les limites de bruits radioélectriques applicables aux appareils numériques de Classe B prescrites dans la norme sur le matériel brouilleur: "Appareils Numériques", NMB-003 édictée par l'Industrie Canada.

## **C** 操作注意事項

1. 本照相機不防水，且不能在下雨或下雪時於戶外使用。若不慎落入水中，應盡速聯絡 Canon 佳能公司特約的服務中心。此外，盡量使照相機遠離鹽氣及高度濕氣。如照相機在海邊使用，用後請立即以乾布徹底擦拭乾淨。
2. 將照相機存放在陰涼、乾燥、無塵的地方，及遠離陽光直射或聚熱地方，如行李箱或汽車後擋風玻璃平台；並避免將照相機放於有樟腦丸及濕氣的地方，必要時請使用乾燥劑。
3. 本照相機內部裝有高壓電路，請勿自行拆解，免生危險。
4. 電池如加以拆解、充電，或因短路及曝露於高溫下或投入火中，均可能引起爆炸或燃燒。
5. 請使用空氣噴刷去除照相機及鏡頭上的灰塵或沙粒，切勿塗抹任何液體擦拭。如需進一步的徹底清潔，請將照相機送至 Canon 佳能公司特約的服務中心。
6. 膠卷裝於照相機內，在經過機場的 X 光檢查時，很可能會被損毀。可要求人工檢查，以避免損害。
7. 膠卷如長期置於照相機內，對其色彩會有不良影響，所以請將拍攝完畢的膠卷，立即予以沖洗。

## **M LANGKAH-LANGKAH PERINGATAN PENGENDALIAN:**

1. Kamera ini tidak telap air dan tidak harus digunakan untuk kegiatan luar semasa hujan ataupun salji. Jika ianya terjatuh ke dalam air, sila hubungi pusat kemudahan perkhidmatan Canon yang bertauliah. Hindari kamera dari terkena semburan garam dan kelembapan yang keterlaluan. Jika digunakan di pantai, sila bersihkan sepenuhnya dan selepas itu lap dengan kain lembut yang kering.
2. Simpan kamera di tempat yang redup, kering dan bebas habuk. Pastikan kamera dihindari dari terkena pancaran terus sinar matahari dan jangan disimpan di tempat panas seperti bonet atau para cermin belakang kereta. Hindari juga dari tempat di mana ubat gegat digunakan dan gunakan pengering di tempat yang berkelembapan tinggi.
3. Jangan cuba membuka badan kamera sendiri kerana terdapat litar voltan berkuasa tinggi di dalam.
4. Bateri mungkin boleh meletup atau terbakar jika tersalah pasang, dicas semula, dipintas, didedahkan kepada suhu tinggi atau dimusnahkan di dalam api.
5. Gunakan berus lembut untuk menanggalkan habuk dan pasir dari lensa dan bahagian dalam kamera. Jangan gunakan sebarang jenis cecair kepada lensa dan badan kamera. Sila bawa kamera ke pusat-pusat kemudahan perkhidmatan Canon untuk pencucian yang sepenuhnya jika diperlukan.
6. Filem yang melalui pemeriksaan X-ray di lapangan terbang mungkin terkena dedahan dan rosak walaupun ianya dimuatkan di dalam kamera. Sila minta kaedah pemeriksaan lain bagi mengelakkan kerosakan.
7. Cetakan semula warna mungkin memberi kesan yang berlawanan jika filem ditinggalkan lama di dalam kamera. Sila hantar kan filem yang telah digunakan, dengan segera untuk pencucian.

## **K** 취급상 주의

1. 이 카메라는 방수가 되지 않으므로 비나 눈이 오는 날에는 실외에서 사용하지 말아 주십시오. 만약 사고 등으로 카메라를 물에 빠뜨렸을 경우에는 캐논 지정 서비스점에 수리를 의뢰해 주십시오. 소금기가 있는 곳이나 습도가 높은 곳에는 놓아두지 말아 주십시오. 만약 해변가에서 사용하신 경우에는 마른 천으로 잘 닦아 주십시오.
2. 카메라는 먼지가 없는 건넌한 곳에 보관하여 주십시오. 직사광선을 받는 곳이나 자동차의 트렁크나 계기판 위와 같이 직사광선을 받는 곳이나 화기 주변에는 놓아두지 말아 주십시오. 줌약을 사용중인 곳이나 습도가 높아 건조제를 사용중인 곳은 피해 주십시오.
3. 카메라에는 고압 회로가 내장되어 있으므로 직접 분해 하지 말아 주십시오.
4. 배터리를 분해, 충전, 방전, 고온방치, 또는 불속에 넣으면 폭발하거나 화재를 일으킬 염려가 있습니다.
5. 렌즈나 카메라 내부의 먼지, 모래 제거에는 송풍브러시를 사용해 주십시오. 렌즈나 몸체는 어떠한 액체로도 닦지 말아 주십시오. 만약 분해소지가 필요한 경우에는 캐논 지정 서비스점에 의뢰해 주십시오.
6. 필름은 카메라에 장전한 채 공항의 X-선 검색기를 통과하면 노출되거나 훼손될 염려가 있습니다. 손상을 방지하기 위해 다른 방법을 강구해 주십시오.
7. 필름을 카메라에 장기간 넣어두면 컬러 해상도를 떨어뜨릴 염려가 있습니다. 필름은 항상 즉시 현상해 주십시오.



---

## **E** Conventions

The following conventions are used in these instructions:

- ① Warnings you should observe when using the camera.
- ② Additional information on using the camera.

---

## **C** 慣用標記

下列是本說明書使用的慣用標記：

- ① 警告您在使用照相機時必須注意的事項。
- ② 使用照相機時的附加資料。

---

## **M** Konvensyen

Konvensyen berikut adalah digunakan dalam arahan ini:

- ① Amaran yang perlu anda perhatikan apabila menggunakan kamera ini.
- ② Maklumat tambahan mengenai penggunaan kamera.

---

## **K** 약정

특기사항에는 다음과 같은기호를 사용하고 있습니다.

- ① 카메라 사용상의 추가정보
- ② 촬영상의 조언

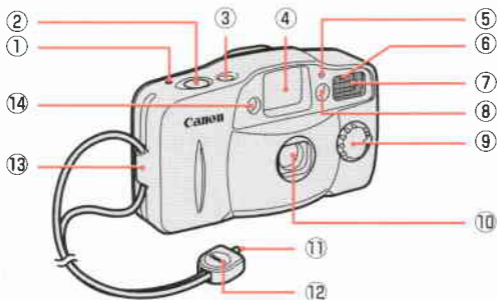

## E Nomenclature

- ① Film Rewind Button
- ② Shutter Button
- ③ Frame Counter
- ④ Viewfinder Window
- ⑤ Light Metering Window
- ⑥ Red-eye Reduction/Self-timer Lamp
- ⑦ Flash
- ⑧ AF Light Receptor
- ⑨ Mode Dial (Main Switch)
- ⑩ Lens
- ⑪ Push-button Release\*

- ⑫ Strap Fixture
- ⑬ Strap Holder
- ⑭ AF Light Emitter

\*Use the projection on the strap fixture to press small buttons such as the film rewind button and the date adjustment buttons.

## C 照相機各部名稱

- ① 膠卷回捲鈕
- ② 快門鈕
- ③ 膠卷格數計算器
- ④ 觀景窗
- ⑤ 測光窗
- ⑥ 防紅眼 / 自拍器燈
- ⑦ 閃光燈
- ⑧ 自動對焦受光器
- ⑨ 模式轉盤 (主開關)

- ⑩ 鏡頭
- ⑪ 按鈕釋放\*
- ⑫ 背帶夾
- ⑬ 背帶扣
- ⑭ 自動對焦投光器

\*請利用背帶扣上的突起部分來按動膠卷回捲鈕和日期調整鈕。



## **M** Tata Nama Sistem

- ① Butang Penggulungan Semula Filem
- ② Butang Pengatup
- ③ Kaunter Bingkai
- ④ Tingkap Pemandang Tilik
- ⑤ Tingkap Pemeteran Cahaya
- ⑥ Lampu Pengurangan Mata Merah/Pemasaan Diri
- ⑦ Lampu Pancaran
- ⑧ Penerima Cahaya AF
- ⑨ Dail Mod (Suis Utama)
- ⑩ Lensa

- ⑪ Pembebas butang tekan\*
- ⑫ Pengikat Tali
- ⑬ Tali Pemegang
- ⑭ Pemancar Cahaya AF

\*Gunakan unjuran pada pengikat tali untuk menekan butang kecil seperti butang penggulungan semula filem dan butang pengubahsuaian tarikh.

## **K** 각부명칭

- ① 필름되감기 버튼
- ② 셔터 버튼
- ③ 촬영매수 카운터
- ④ 파인더 창
- ⑤ 라이트미터링 창
- ⑥ 적목완화램프/자동타이머 램프
- ⑦ 플래시
- ⑧ AF 라이트 센서
- ⑨ 모드 다이얼 (메인 스위치)

- ⑩ 렌즈
- ⑪ 푸시버튼 릴리즈\*
- ⑫ 손잡이 고정부
- ⑬ 손잡이 홀더
- ⑭ AF 라이트 발광기

\* 필름되감기 버튼이나 날짜 표시 전환 버튼 등의 작은 버튼을 누를 때에는 손잡이 고정쇠의 위에 있는 돌기부를 사용해 주십시오.

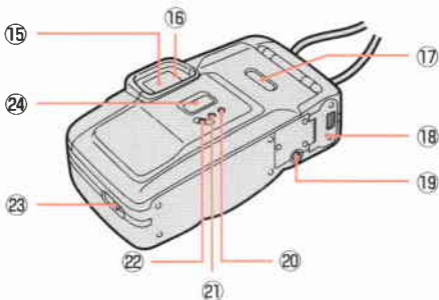

## E Nomenclature

- ⑮ Viewfinder
- ⑯ Green Indicator
- ⑰ Film Check Window
- ⑱ Battery Cover
- ⑲ Tripod Socket
- ⑳ SET Button **DATE**
- ㉑ SELECT Button **DATE**
- ㉒ MODE Button **DATE**
- ㉓ Back Cover Open/Close Latch
- ㉔ Date Display **DATE**

## C 照相機各部名稱

- ⑮ 觀景窗
- ⑯ 綠色指示燈
- ⑰ 膠卷檢視窗
- ⑱ 電池蓋
- ⑲ 三腳架螺絲孔
- ⑳ SET (設定) 按鈕 **DATE**
- ㉑ SELECT (選擇) 按鈕 **DATE**
- ㉒ MODE (模式) 按鈕 **DATE**
- ㉓ 背蓋開關栓
- ㉔ 日期顯示 **DATE**

## **M** Tata Nama Sistem

- ⑮ Pemidang Tilik
- ⑯ Penunjuk Hijau
- ⑰ Tingkap Pemeriksa Filem
- ⑱ Penutup Bateri
- ⑲ Soket Tripod
- ⑳ Butang SET **DATE**
- ㉑ Butang SELECT **DATE**
- ㉒ Butang MODE **DATE**
- ㉓ Penyelak Buka/Tutup Penutup Belakang
- ㉔ Paparan Tarikh **DATE**

## **K** 각부명칭

- ⑮ 뷰파인더
- ⑯ 녹색 지시계
- ⑰ 필름 확인창
- ⑱ 배터리커버
- ⑲ 삼각대소켓
- ⑳ SET 버튼 **DATE**
- ㉑ SELECT 버튼 **DATE**
- ㉒ MODE 버튼 **DATE**
- ㉓ 백커버 개폐 잠금쇠
- ㉔ 날짜 디스플레이 **DATE**



## Thank you for purchasing this Canon product.

Before taking pictures, please read these instructions carefully for a thorough understanding of how the camera operates.

### Table of Contents

Handling Precautions .....	2
Conventions .....	7
Nomenclature .....	8
Table of Contents .....	12
<b>1</b> Loading the Batteries/Turning the Power On .....	16
<b>2</b> Loading the Film .....	20
<b>3</b> Holding the Camera .....	24
<b>4</b> Viewfinder .....	26
Green Indicator .....	26
<b>5</b> Shutter Button Action .....	28
<b>6</b> Taking Pictures (Fully Automatic) .....	30
<b>7</b> Removing the Film .....	34
<b>8</b> Changing the Shooting Mode .....	38
<b>1</b> Flash AUTO with Red-eye Reduction Mode .....	38
Red-eye Reduction Function .....	40
<b>2</b> Flash ON Mode .....	44
<b>3</b> Flash OFF Mode .....	46
<b>4</b> Self-timer Mode .....	48
<b>9</b> Imprinting the Date and Time <b>DATE</b> .....	52
<b>10</b> Setting the Date <b>DATE</b> .....	54
<b>11</b> Setting the Time <b>DATE</b> .....	58
Replacing the Date Battery <b>DATE</b> .....	60
Troubleshooting .....	64
Specifications .....	68

Please note that these instructions are for both the model with the date function and the model without the date function. Information relevant only to the model with the date function is marked with the **DATE** symbol.

## C 感謝您選購本 Canon 佳能產品。

拍照片前，請先詳細閱讀本說明書以便了解本照相機的操作方法。

### 目錄

操作注意事項 .....	4
慣用標記 .....	7
照相機各部名稱 .....	8
目錄 .....	13
1 安裝電池 / 打開電源 .....	16
2 安裝膠卷 .....	20
3 握持照相機 .....	24
4 觀景窗 .....	26
綠色指示燈 .....	26
5 快門鈕的運作 .....	28
6 拍攝照片 (全自動) .....	30
7 取出膠卷 .....	34
8 改變拍攝模式 .....	38
① 附防紅眼效果的閃光燈 AUTO (自動) 模式 .....	38
防紅眼功能 .....	40
② 閃光燈開啟模式 .....	44
③ 閃光燈關閉模式 .....	46
④ 自拍器模式 .....	48
9 加印日期和時間 <b>DATE</b> .....	52
10 設定日期 <b>DATE</b> .....	54
11 設定時間 <b>DATE</b> .....	58
更換日期用電池 <b>DATE</b> .....	60
簡易故障解除方法 .....	65
規格 .....	69

請注意本說明書兼用於帶日期功能和不帶日期功能的型號。資料只有關於帶日期功能的型號者，將注有 **DATE** 標記。



## Terimakasih kerana pembelian keluaran Canon ini.

Sebelum mengambil gambar, sila baca arahan berikut dengan teliti untuk mendapatkan pemahaman yang sepenuhnya mengenai bagaimana kamera ini beroperasi.

### Kandungan Jadual

LANGKAH-LANGKAH PERINGATAN PENGENDALIAN .....	5
Konvensyen .....	7
Tata Nama Sistem .....	9
Kandungan Jadual .....	14
1 Memasukkan Bateri/Menghidupkan Kuasa .....	17
2 Memasukkan Filem .....	21
3 Memegang Kamera .....	25
4 Pemandang Tilik .....	27
Penunjuk Hijau .....	27
5 Pergerakan Butang Pengatup .....	29
6 Mengambil Gambar (Automatik Sepenuh) .....	31
7 Mengeluarkan Filem .....	35
8 Menukar Mod Penggambaran .....	39
1 Mod Lampu Pancaran AUTO dengan Pengurangan Mata	
Merah .....	39
Fungsi Pengurangan Mata Merah .....	41
2 Mod Lampu Pancaran Hidup/ON .....	45
3 Mod Lampu Pancaran Padam/OFF .....	47
4 Mod Pemasakan Diri .....	49
9 Mengecap Tarikh dan Masa <b>DATE</b> .....	53
10 Penetapan Tarikh <b>DATE</b> .....	55
11 Penetapan Masa <b>DATE</b> .....	59
Menggantikan Tarikh Bateri <b>DATE</b> .....	61
Penyelesaian Masalah .....	66
Spesifikasi .....	70

Untuk makluman, arahan ini adalah untuk kedua-dua model, iaitu model dengan fungsi tarikh dan model tanpa fungsi tarikh. Maklumat yang hanya berkaitan kepada model dengan fungsi tarikh ditandakan dengan simbol **DATE**.

**K** 본 책은 제품을 구입해 주셔서 대단히 감사합니다.  
 카메라를 사용하기 전에 본 사용설명서를 잘 읽으시고 카메라의 조작방법을 충분히 숙지하여 주시기 바랍니다.

## 목차

취급상 주의	6
약정	7
각부명칭	9
목차	15
1 배터리의 충전/전원을 ON 으로 전환	17
2 필름의 충전	21
3 카메라 고정	25
4 뷰파인더	27
녹색 지시계	27
5 셔터버튼의 조작	29
6 촬영(전자동)	31
7 필름교환	35
8 촬영모드의 변경	39
1 적목완화기능을 사용하는 플래시 AUTO	39
적목완화기능	41
2 플래시ON 모드	45
3 플래시OFF 모드	47
4 자동타이머 모드	49
9 날짜 및 시간 입력 <b>DATE</b>	53
10 날짜 세팅 <b>DATE</b>	55
11 시간 세팅	59
날짜배터리 교환 <b>DATE</b>	61
촬영트러블	67
사양	71

이 사용설명서는 날짜기능이 있는 모델과 날짜기능이 없는 모델 공용입니다. 특히 날짜기능이 있는 모델에만 관계되는 정보는 **DATE** 마크로 표시하고 있습니다.

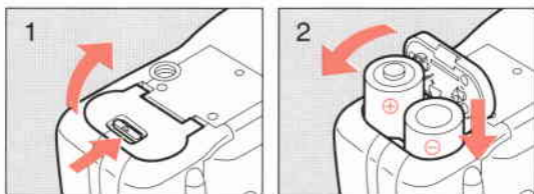

## **E** 1 Loading the Batteries/Turning the Power On

This camera uses two LR6 AA-size batteries.

1. Open the battery cover on the bottom of the camera.
2. Load the batteries with the + and – terminals correctly positioned. Then, close the battery cover.
3. Turn the mode dial to **Q AUTO** (turn the camera on) and check the batteries.
  - Make sure that the lens cover is completely open.
  - If the green indicator lights up when the shutter button is pressed halfway, the batteries are in good condition.

## **C** 1 安裝電池 / 打開電源

本照相機使用兩顆 LR6 的 3 號電池。

1. 打開照相機底面的電池蓋。
2. 裝入電池。必須裝對電池電極，然後關上電池蓋。
3. 將模式轉盤推至 **Q AUTO**（開啟照相機電源）並檢查電池。
  - 確認鏡頭蓋是否完全打開了。
  - 當半按下快門鈕時，如果綠色指示燈點亮了，即表示電池仍處於良好條件。



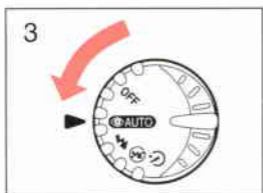

## **M** 1 Memasukkan Bateri/Menghidupkan Kuasa

Kamera ini menggunakan dua biji bateri LR6 bersaiz AA.

1. Buka penutup bateri di bahagian bawah kamera.
2. Masukkan bateri dengan kedudukan terminal + dan - dengan betul. Kemudian tutup penutup bateri.
3. Tukarkan dail mod ke **AUTO** (hidupkan kuasa kamera) dan periksa bateri-bateri.
  - Pastikan penutup lensa dibuka sepenuhnya.
  - Jika lampu penunjuk hijau menyala apabila butang pengatup ditekan separuh, bateri berada dalam keadaan baik.

## **K** 1 배터리의 충전/전원을 ON으로 전환

이 카메라는 LR6 AA 사이즈 배터리를 사용합니다.

1. 카메라 하부의 배터리 커버를 엽니다.
2. 배터리를 +극과 -극을 바른 방향으로 충전합니다. 배터리 커버를 닫습니다.
3. 모드 다이얼을 **AUTO** 측으로 돌리고(카메라의 전원이 들어옴) 배터리 잔량을 체크합니다.
  - 렌즈커버가 완전히 열려 있는지를 확인합니다.
  - 셔터 버튼을 반쯤 눌렀을 때 녹색 지시계가 점등하면 배터리의 잔량이 충분한 상태입니다.

**E**

- Always check the batteries before taking any pictures (→ p. 64).
- Do not use nickel-cadmium or lithium batteries.
- When replacing the batteries, be sure to replace both batteries at the same time with new ones.
- Always remove the batteries from the camera if you will not be using it for a long time.



- Shooting capacity: approximately 50 rolls of 24-exposure film with 50% flash use, when using alkaline batteries. (Data based on Canon's Standard Method.)
- Long-life alkaline batteries are recommended.

**C**

- 拍照前，請先檢查電池。(→65頁)
- 不可使用鎳鎘電池或鋰電池。
- 更換電池時，請一起換新，不要混用新舊電池。
- 凡準備長期不使用照相時，都請取出電池保管。



- 拍攝能力：50% 使用閃光燈時，約可拍攝 50 卷 24 格膠卷。(此數據及依據 Canon 佳能公司標準測定方法而得。)
- 最好使用長壽命的鹼性電池。

**M**

- Sentiasa periksa bateri sebelum mengambil gambar. (→ mukasurat 66)
- Jangan gunakan bateri Nickel-Cadmium atau lithium.
- Apabila menggantikan bateri-bateri tersebut, pastikan untuk menggantikan kedua-dua bateri itu pada masa yang sama dengan yang baru.
- Sentiasa keluarkan bateri dari kamera jika anda tidak akan menggunakannya bagi tempoh masa yang lama.



- Kapasiti penggambaran: bersamaan kira-kira 50 gulungan filem 24 dedahan dengan 50% penggunaan lampu pancaran. (Data berdasarkan kepada Kaedah Ujian Piawai Canon).
- Bateri alkali berhayat panjang adalah disyorkan.

**K**

- 촬영하기 전에 반드시 배터리를 체크해 주십시오. (→ 67)
- 니카드 또는 리튬 전지는 사용하지 마십시오.
- 배터리를 교환할 때에는 반드시 모두 새 배터리로 교환하여 주십시오.
- 카메라를 장기간 사용하지 않을 때에는 반드시 배터리를 꺼내 두도록 하십시오.



- 촬영용량: 플래시를 50%정도 사용할 경우 24컷 짜리 필름 약 50통을 촬영할 수 있습니다. (이 데이터는 캐논 표준테스트법 기준임).
- 수명이 긴 알카리 배터리를 사용하실 것을 권합니다.

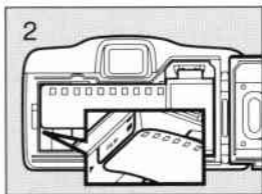
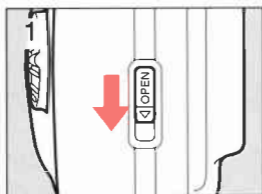

## **E** 2 Loading the Film

Use DX-coded ISO 100, 200 or 400 film. The camera automatically detects the film speed and selects the correct setting.

### **1. Open the back cover.**

### **2. Load a new film.**

- Pull the film tip across until it reaches the film tip position mark.

### **3. Close the back cover.**

- The film automatically advances, and "1" is displayed in the frame counter.

## **C** 2 安裝膠卷

使用 DX 編碼 ISO 100, 200 或 400 膠卷。照相機將自動檢測膠片感光度並選擇正確的設定。

### **1. 打開照相機背蓋。**

### **2. 裝入新膠卷。**

- 小心拉出膠卷片頭至標記處。

### **3. 關上背蓋。**

- 膠卷將自動進片並在格數計算器上顯示“1”。

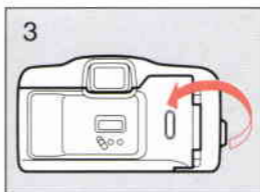
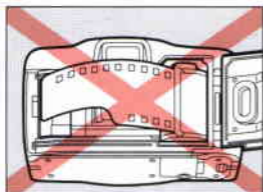

## **M** 2 Memasukkan Filem

Gunakan filem pengkodan DX ISO 100, 200 atau 400. Kamera tersebut secara automatik akan mengesan kelajuan filem dan memilih penetapan yang betul.

### 1. Buka penutup belakang.

### 2. Masukkan filem baru.

- Tarik hujung filem ke sebelah sehingga ia mencapai tanda kedudukan hujung filem.

### 3. Tutup penutup belakang.

- Filem secara automatik akan mara, dan "1" dipaparkan di kaunter bingkai.

## **K** 2 필름의 장전

DX 코드 필름 ISO 100, 200, 400 중의 하나를 사용해 주십시오. 이 카메라는 카메라 필름을 자동적으로 검출하고 바른 세트를 선택합니다.

### 1. 백커버를 엽니다.

### 2. 새 필름을 넣습니다.

- 필름의 끝을 잡고 필름끝 위치 마크까지 오도록 당깁니다.

### 3. 백커버를 닫습니다.

- 필름이 자동적으로 실행되어 촬영매수 카운터에 "1"이 디스플레이 됩니다.

---

**E**

- If "S" is still displayed in the frame counter, reload the film.
- If you do insert the batteries after loading film, press the shutter button until "1" is displayed in the frame counter.
- This camera is designed to be used with negative film only. Therefore, slide film cannot be used.

---

**C**

- 如果在格數計算器上仍然顯示著 "S" 時，即請重裝一下膠卷。
- 如果安裝膠卷後才裝電池，請按下快門鈕至格數計算器顯示 "1"。
- 本相機專用於拍攝照像底片的照片，不能使用幻燈片膠卷。

**M**

- Jika "S" masih lagi dipaparkan di kaunter bingkai , masukkan semula filem.
- Jika anda memasukkan bateri selepas memasukkan filem, tekan butang pengatup sehingga "1" dipaparkan di kaunter bingkai.
- Kamera ini di rekabentuk untuk digunakan dengan filem negatif sahaja. Dengan itu, filem slaid tidak boleh digunakan.

**K**

- 촬영매수 카운터에 "S"가 디스플레이되어 있는 경우에는 필름을 다시 넣어 주십시오.
- 필름을 넣은 후에 배터리를 넣은 경우에는 촬영 매수 카운터에 "1"이 디스플레이 될 때까지 셔터 버튼을 눌러 주십시오.
- 이 카메라는 네거티브 필름 전용입니다. 슬라이드 필름은 사용할 수 없습니다.



### **E** 3 Holding the Camera

To take sharp pictures, hold the camera firmly so that it does not move.

- Hold the camera in both hands.
- Rest your elbows lightly against your body.
- Look through the viewfinder so that the camera is touching your forehead.



- When holding the camera, take care not to block the lens, AF light emitter or receptor, light metering window or flash with your fingers or hair.

### **C** 3 握持照相機

為保證能照得清晰的照片，拍攝時，須拿穩照相機不要晃動。

- 用兩手拿穩照相機。
- 讓手肘輕靠住身體。
- 注視觀景窗使照相機緊貼前額。



- 拿照相機時，須注意別讓自己的手指或頭髮遮住了鏡頭、AF（自動對焦）投光器或受光器、測光窗、或閃光燈等。





### **M** 3 Memegang Kamera

Untuk mengambil gambar yang jelas, pegang kamera dengan kuat supaya ianya tidak bergerak.

- Pegang kamera dengan kedua-dua belah tangan.
- Rehatkan siku anda dengan lembut terhadap tubuh badan anda.
- Lihat melalui pemidang tilik, dengan itu kamera boleh menyentuh dahi anda.



- Apabila memegang kamera, sila berhati-hati supaya jari-jari dan rambut anda tidak menghalang lensa, pemancar atau penerima cahaya AF, tingkap pemeteran cahaya atau lampu pancaran.

### **K** 3 카메라 고정

선명한 사진을 촬영하기 위해서는 카메라가 흔들리지 않도록 단단히 고정해 주십시오.

- 카메라를 양손으로 단단히 잡습니다.
- 팔꿈치를 몸에 가볍게 붙입니다.
- 카메라를 이마에 대고 뷰파인더를 통하여 피사체를 봅니다.



- 카메라 고정시에 머리카락, 손가락 등이 렌즈, AF라이트 발광기 및 센서, 라이트미터링 창, 플래시 등을 가리지 않도록 주의해 주십시오.

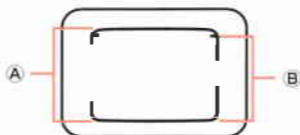

## **E** 4 Viewfinder

### **Viewfinder Frames**

#### **A** Picture Frame

Compose the picture inside this frame.

#### **B** Close-up frame

When the shooting distance is between 0.8 and 1 m (2.6 and 3.3 ft.), compose your picture within this frame. The area above this frame will not be taken.

### **Green Indicator**

(when the shutter button is pressed halfway)

Lights up: Ready for shooting/Self-timer operates

Not lit: Flash not charged or battery power is low.

## **C** 4 觀景窗

### **觀景窗框**

#### **A** 影像框

在此框內進行構圖。

#### **B** 近攝框

當拍攝距離是在0.8米和1米（2.6和3.3呎）之間時，請在此框進行構圖。超出此框範圍外的，將不能攝影。

### **綠色指示燈**

（半按下快門鈕時）

點亮：已準備好可以拍攝 / 自拍器操作中。

熄滅：閃光燈沒有充電或電池電力低。

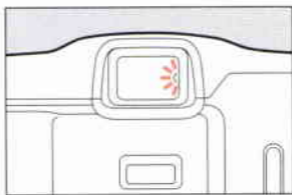

## M 4 Pemandang Tilik

### Bingkai Pemandang Tilik

#### Ⓐ Bingkai Gambar

Rencanakan gambar di dalam bingkai ini.

#### Ⓑ Bingkai Jarak Dekat (Close-up)

Apabila jarak penggambaran adalah di antara 0.8 dan 1 m (2.6 dan 3.3 kaki), rencanakan gambar anda di antara bingkai ini. Kawasan di atas bingkai ini tidak akan diambil.

### Penunjuk Hijau

(Apabila butang pengatup ditekan separuh)

Menyala: Sedia untuk penggambaran/Pemasaan diri beroperasi

Padam: Lampu pancaran tidak dicaj atau kuasa bateri lemah

## K 4 뷰 파인더

### 뷰 파인더 프레임

#### Ⓐ 촬영프레임

이 프레임 내에서 피사체의 구도를 잡습니다.

#### Ⓑ 클로즈업 프레임

촬영거리가 0.8 ~ 1 m(2.6 ~ 3.3 ft)일 경우에는 이 프레임 내에서 피사체의 구도를 잡습니다. 이 프레임 바깥 부분은 촬영되지 않습니다.

### 녹색 지시계

(셔터버튼을 반쯤 누른 경우)

점등 : 촬영가능/자동타이머가 작동

소등 : 플래시의 충전불량 또는 배터리가 소모되어 있습니다.

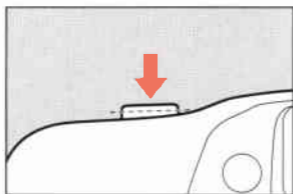

## **E** 5 Shutter Button Action

This camera has a two-step shutter button. Press it halfway to focus and the green indicator is lit. Then press it fully to release the shutter. Be sure to press the shutter button slowly and gently.



- Check that the lens cover is fully open before pressing the shutter button. The shutter does not operate unless the lens cover is fully open.
- There is a very short interval between the shutter button being pressed and the shutter operating. As a general guide, it is best to hold the camera still until you hear the film start to wind forward.

## **C** 5 快門鈕的運作

本照相機的快門鈕分兩級操作。半按下快門鈕用以對焦並點亮綠色指示燈。然後完全按下以釋放快門。請和緩輕穩地按下快門鈕。



- 按快門鈕前，必須檢查鏡頭蓋是否完全打開了。鏡頭蓋如不完全打開，快門是不能操作的。
- 在按下快門鈕和快門開始釋放操作之間有一個短暫的間隔，因此，應該在按下快門鈕後仍須拿穩照相機至聽到進片聲為止。

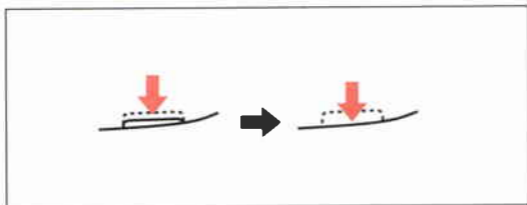

## M 5 Pergerakan Butang Pengatup

Kamera ini mempunyai butang pengatup dua langkah. Tekan ianya separuh untuk memokus dan penunjuk hijau akan menyala. Kemudian tekan dengan sepenuhnya untuk membebaskan butang pengatup. Pastikan untuk menekan butang pengatup dengan perlahan dan lembut.



- Sila periksa yang penutup lensa dibuka dengan sepenuhnya sebelum menekan butang pengatup. Pengatup tidak akan beroperasi kecuali penutup lensa dibuka sepenuhnya.
- Terdapat ruang masa yang pendek di antara butang pengatup yang ditekan dengan operasi pengatup. Sebagai panduan am, adalah baik untuk terus memegang kamera sebegitu sehinggalah anda mendengar filem mula untuk mara.

## K 5 셔터버튼의 조작

이 카메라는 2단계 셔터버튼으로 설계되어 있습니다. 반쯤 눌러 초점을 맞추면 녹색 지시계가 점등합니다. 다음에 완전히 누르면 셔터가 작동합니다. 셔터버튼을 반드시 천천히 조용히 눌러 주십시오.



- 셔터버튼을 누르기 전에 렌즈 커버가 완전히 열려 있는지를 확인해 주십시오. 렌즈 커버가 완전히 열려 있지 않으면 셔터는 작동하지 않습니다.
- 셔터를 누른 후 셔터가 작동하기까지의 시간은 상당히 짧습니다. 일반적으로 필름이 감기는 소리가 들릴 때까지 카메라를 움직이지 않도록 하는 것이 좋을 것입니다.

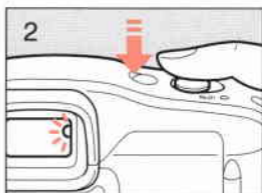
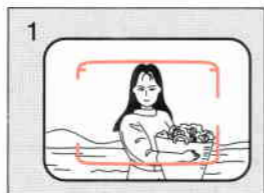

## **E** 6 Taking Pictures (Fully Automatic)

Opening the lens cover turns the camera on and sets the mode to fully automatic (Auto Flash).

Stand at least 0.8 m (2.6 ft.) from the subject to be taken.

1. Place the center of the viewfinder over the subject.
2. Press the shutter button halfway and check that the green indicator lights up.
3. While pressing the shutter button, compose your picture.
4. Press the shutter button fully.
  - In low light conditions, the flash operates automatically.

## **C** 6 拍攝照片（全自動）

打開鏡頭蓋以打開照相機電源並將其設定為全自動模式（自動閃燈）。

須距離主體至少 0.8 米（2.6 呎）進行拍攝。

1. 把主體置於觀景窗的中央。
2. 半按下快門鈕並檢查綠色指示燈是否點亮了。
3. 半按著快門鈕，同時給照片進行構圖。
4. 全按下快門鈕。
  - 在弱光下拍攝時，閃光燈將自動閃亮。

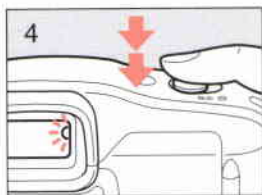

**M** **6 Mengambil Gambar (Automatik Sepenuh)**  
 Membuka penutup lensa akan menghidupkan kuasa kamera dan menyetekkan mod kepada automatik sepenuhnya (Lampu pancaran auto). Berdiri sekurang-kurangnya 0.8 m (2.6 kaki) dari subjek yang mahu diambil.

1. Letakkan bahagian tengah pimidang tilik pada subjek.
2. Tekan butang pengatup separuh dan periksa yang penunjuk hijau menyala.
3. Sementara menekan butang pengatup, rencanakan gambar anda.
4. Tekan butang pengatup sepenuhnya.
  - Di bawah keadaan cahaya kurang terang, lampu pancaran akan menyala secara automatik.

**K** **6 촬영 (전자동)**  
 카메라의 렌즈커버를 열면 전자동모드로 세팅됩니다(자동플래시). 촬영하고자 하는 피사체로부터 0.8 m(2.6 ft.)이상 떨어져 주십시오.

1. 뷰파인더의 중심에 피사체를 맞춥니다.
2. 셔터버튼을 반쯤 누르고 녹색 지시계가 점등하고 있는지를 확인합니다.
3. 셔터버튼을 누른채 구도를 잡습니다.
4. 셔터버튼을 완전히 누릅니다.
  - 어두운 곳에서는 플래시가 자동적으로 작동합니다.

---

**E**



- When the camera is not being used, always close the lens cover to protect the lens against dirt and dust.

---

**C**



- 照相機不拍照時，請關上鏡頭蓋以防鏡頭上沾染塵垢。



**M**



- Apabila kamera tidak digunakan, selalu tutup penutup lensa bagi melindungi lensa dari terkena kotoran dan habuk.

**K**



- 카메라를 사용하지 않을 때는 먼지나 오물로부터 카메라를 보호하기 위해 항상 렌즈커버를 닫아 주십시오.

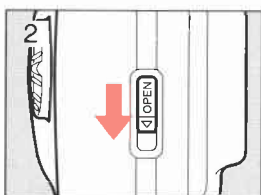
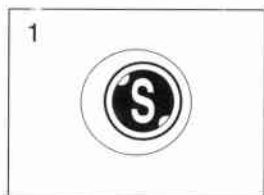

## **E** 7 Removing the Film

The film rewinds automatically when the last frame is exposed.

The number shown in the frame counter decreases during rewinding. Check that the frame counter has returned to "S", and that the motor has stopped, then remove the film.

1. Check that the frame counter has returned to "S".
2. Open the back cover.
3. Remove the film.

## **C** 7 取出膠卷

當拍攝完最後一格膠片之後，膠卷即將自動地回捲。回捲中，格數計算器將倒數計數。確認了格數計算器已轉回到“S”並停止了電動機轉動之後，才取膠卷。

1. 查看格數計算器已轉回到“S”。
2. 打開照相機背蓋。
3. 取出膠卷。

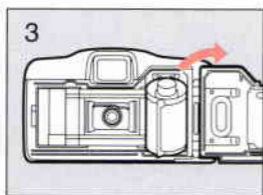

## **M** 7 Mengeluarkan Filem

Filem akan bergulung semula secara automatik apabila bingkai terakhir digunakan.

Nombor di kaunter bingkai menurun sewaktu pengulungan semula.

Sila periksa bahawa kaunter bingkai kembali ke "S" dan motor telah berhenti, kemudian keluarkan filem.

1. Periksa yang kaunter bingkai kembali ke "S".
2. Buka penutup belakang.
3. Keluarkan filem.

## **K** 7 필름교환

필름을 끝까지 다 사용하면 자동적으로 되감기가 됩니다. 필름이 되감기는 동안 촬영매수 카운터에 디스플레이되는 숫자는 내려갑니다. 촬영매수 카운터가 "S"로 리셋되고 모터가 정지된 것을 확인한 다음 필름을 빼내 주십시오.

1. 촬영매수 카운터의 디스플레이가 "S"인 것을 확인합니다.
2. 백커버를 엽니다.
3. 필름을 빼냅니다.

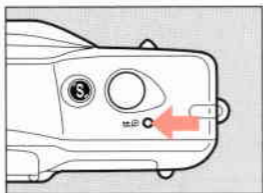

## **E** Removing the film in mid-roll

- Press the film rewind button .



- Exposures taken after those indicated on the film roll may be cut off.



- If, while rewinding the film, the batteries run out, and you must replace them, press the film rewind button . The film will start to rewind again.
- Use the projection on the strap fixture.

## **C** 在膠卷中途卸下膠卷

- 按下膠卷回捲鈕 .



- 若超過膠卷張數的曝光可能會被切去。



- 回捲途中，如果電池用完了，必須更換電池，然後按下膠卷回捲鈕 。膠卷即將再開始回捲。
- 請用背帶扣上的突起部分。

## **M** Mengeluarkan filem di pertengahan gulungan.

- Tekan butang penggulungan semula filem .



- Dedahan yang diambil selepas apa yang dinyatakan di atas gulungan filem mungkin akan dipotong.



- Jika bateri kehabisan kuasa sewaktu penggulungan semula filem, anda harus menggantikannya dan kemudian tekan butang penggulungan semula filem . Filem akan mula digulung semula.
- Gunakan unjuran pada pengikat tali untuk menekan butang tersebut.

## **K** 도중에 필름 되감기

- 필름 되감기 버튼  를 눌러 주십시오.



- 필름에 표시되어 있는 컷트수를 초과한 사진은 삭제되는 경우가 있습니다.



- 필름의 되감기 중에 배터리가 소모되어 교환해야 하는 경우에는 필름 되감기 버튼  를 눌러 주십시오. 필름이 되감집니다.
- 손잡이 고정쇠의 돌기부를 사용해 주십시오.

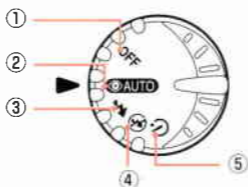

## **E** 8 Changing the Shooting Mode

The flash can be made to fire or can be turned off. Choose the mode suitable for the subject or place you are shooting.

**Turn the mode dial.**

- ① Power OFF
- ② Flash AUTO with red-eye reduction
- ③ Flash ON
- ④ Flash OFF
- ⑤ Self-timer

### ① Flash AUTO with Red-eye Reduction Mode

In low light conditions, the red-eye reduction lamp lights and then the flash fires.

**Turn the mode dial to .**

## **C** 8 改變拍攝模式

閃光燈可使每次拍攝都閃光或不閃光。請配合主體或拍攝地方的條件選擇適當的拍攝模式。

**轉動模式轉盤。**

- ① 電源 OFF (關掉)
- ② 附防紅眼效果的 AUTO (自動) 閃光燈
- ③ 閃光燈 ON (開啟)
- ④ 閃光燈 OFF (關掉)
- ⑤ 自拍器

### ① 附防紅眼效果的閃光燈 AUTO (自動) 模式

在弱光下拍攝時，防紅眼燈將點亮，然後閃光燈才閃光。

**將模式轉盤推至 .**

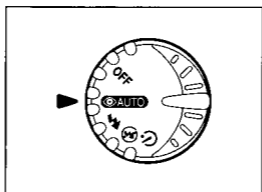

## **M** 8 **Menukar Mod Penggambaran**

Lampu pancaran boleh dijadikan menyala atau boleh dipadamkan. Pilih mod yang bersesuaian untuk subjek atau tempat penggambaran anda.

### **Tukar dail mod.**

- |  |                      |
|--|----------------------|
| ① Kuasa dipadamkan                                   | ④ Lampu pancaran OFF |
| ② Lampu pancaran AUTO dengan pengurangan mata merah. |                      |
| ③ Lampu pancaran ON                                  | ⑤ Pemasakan diri     |

### ① **Mod Lampu Pancaran AUTO dengan Pengurangan Mata Merah**

Di bawah keadaan cahaya kurang terang, lampu pengurangan mata merah menyala dan kemudian lampu pancaran memancar.

**Tukar dail mod ke** **AUTO**.

## **K** 8 **촬영모드의 변경**

플래시는 임의로 발광시키거나 정지시킬 수 있습니다. 촬영 장소나 피사체에 따라 가장 적합한 모드를 선택해 주십시오.

모드 다이얼을 돌려 모드를 선택합니다.

- |                         |           |
|-------------------------|-----------|
| ① 전원 OFF                | ④ 플래시 OFF |
| ② 적목완화기능을 사용하는 플래시 AUTO | ⑤ 자동타이머   |
| ③ 플래시 ON                |           |

### ① **적목완화기능을 사용하는 플래시 AUTO**

어두운 곳에서는 적목완화램프가 점등한 후 플래시가 발광합니다.

모드 다이얼로 **AUTO** 를 선택합니다.



## **E** Red-eye Reduction Function

People in photographs taken with a flash in low light conditions often appear to have glowing red eyes. This phenomenon is called "red-eye" and occurs when the light of the flash is reflected off the subject's retina.

When using **Ⓢ AUTO** or **⚡** mode, in dark, or low light, conditions, light the red-eye reduction lamp before using the flash. This causes the subject's pupil to contract and thereby reduces the likelihood of red-eye.

- To reduce the likelihood of red-eye when taking pictures of people in low light conditions, press the shutter button halfway. Press the button fully to release the shutter about one second after the green indicator lights.

## **C** 防紅眼功能

在弱光下使用閃光燈所拍攝的照片人物常出現紅眼現象。這種現象稱為“紅眼”，是由於閃燈的光線反射於視網膜上所致的。

當使用閃光燈 **Ⓢ AUTO** 或 **⚡** 模式時，在陰暗，或低照度條件下，防紅眼燈將在閃光燈閃光前大約一秒即先點亮。這可使主體的眼睛瞳孔縮少而減低紅眼現象。

- 在低照度條件下拍攝人物照片而想要減低紅眼現象時，先半按下快門鈕等點亮綠色燈大約一秒鐘之後而全按下快門鈕以釋放相機快門。



## **M** **fungsi Pengurangan Mata Merah**

Gambar orang yang diambil dengan menggunakan lampu pancaran di bawah keadaan cahaya kurang terang selalu kelihatan terdapat mata merah yang bersinar. Fenomena ini dipanggil “mata merah” dan berlaku apabila cahaya lampu pancaran memantulkan retina mata subjek.

Apabila menggunakan mod **AUTO** atau **☿** di bawah keadaan gelap atau cahaya kurang terang, nyalakan lampu pengurangan mata merah kira-kira satu saat sebelum menggunakan lampu pancaran. Ini menyebabkan anak mata subjek akan mengecil dan seterusnya mengurangkan kelihatannya mata merah.

- Untuk mengurangkan kelihatannya mata merah apabila mengambil gambar orang di bawah keadaan cahaya kurang terang, tekan butang pengatup separuh. Tekan butang tersebut sepenuhnya untuk membebaskan pengatup kira-kira satu saat selepas penunjuk hijau menyala

## **K** **적목완화기능**

어두운 곳에서 플래시 촬영을 하면 사진에 피사체의 눈이 빨갛게 찍히는 경우가 있습니다. 이런 현상을 “적목”이라고 하며, 이는 플래시의 빛이 망막에 반사되어 발생합니다.

**AUTO** 또는 **☿** 모드에서는 어두운 장소나 조명이 약한 장소에서 플래시가 발광하기 전에 약 1초간 적목완화램프가 점등합니다. 이것은 피사체의 동공을 수축시켜 적목을 방지해 줍니다.

- 어두운 장소에서 인물을 촬영하는 경우 적목현상을 방지하기 위해서는, 셔터 버튼을 반쯤 눌러 녹색 지시계를 점등시킨 다음 약 1초 후에 버튼을 완전히 눌러 셔터를 개방합니다.

**E**

- If you press the shutter button fully before the green indicator lights up, the shutter will release, but the red-eye reduction function will not operate.



#### **Important guidelines for using the red-eye reduction function**

1. This function is not effective unless the subject looks directly at the red-eye reduction lamp while it is lit. Be sure to tell your subject to look straight at the lamp.
2. Stay within 2 m (6.6 ft.) of your subject.
3. The efficacy of the red-eye reduction function varies from person to person.
4. Try to raise the ambient light level as much as possible.

**C**

- 如果在綠色指示燈點亮前便全按下快門鈕，快門雖釋放了，但防紅眼功能並不能操作。



#### **使用防紅眼功能的重要準則**

1. 本功能必須讓主體直接注視著亮著的防紅眼燈才能有效。必須告訴主體注視相機上的防紅眼燈。
2. 距離主體 2 米（6.6 呎）以內。
3. 防紅眼功能的效果因人而異。
4. 盡量提高四周環境的照明水平。

**M**

- Jika anda menekan butang pengatup sepenuhnya sebelum penunjuk hijau menyala, pengatup akan dibebaskan tetapi fungsi pengurangan mata merah tidak akan beroperasi.



#### **Panduan penting untuk menggunakan fungsi pengurangan mata merah.**

1. Fungsi ini tidak berkesan kecuali subjek melihat terus pada lampu pengurangan mata merah sewaktu ianya menyala. Pastikan untuk memberitahu subjek anda supaya melihat tepat pada lampu tersebut.
2. Berada dalam lingkungan 2 m (6.6 kaki) dari subjek anda.
3. Keberkesanan fungsi pengurangan mata merah berbeza dari seseorang ke seseorang yang lain.
4. Cuba tingkatkan paras cahaya ambien sebanyak mana yang boleh.

**K**

- 녹색 지시계가 점등하기 전에 셔터버튼을 완전히 누르면 셔터는 작동하지만 적목완화기능은 작동하지 않습니다.



#### **적목완화기능 사용시의 주의사항**

1. 이 기능은 적목완화 램프가 점등하고 있을 때에 피사체가 램프를 직접 보지 않으면 효과가 없습니다. 모델에게 램프를 똑바로 보도록 조언해 주십시오.
2. 피사체와의 거리를 약 2 m(6.6 ft.) 이내로 유지합니다.
3. 적목완화기능의 효과는 사람에 따라 다릅니다.
4. 주변의 조명 레벨을 되도록 높여 주십시오.

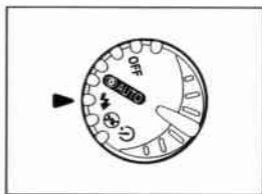

## E ② Flash ON Mode

In this mode, the flash operates regardless of the lighting conditions. Use this mode to soften the contrast when a backlit subject is taken in daylight.

Turn the mode dial to .

Flash Distance Range (with color print film)

ISO 100	ISO 400
0.8 to 3.4 m (2.6 to 11.2 ft.)	0.8 to 6.8 m (2.6 to 22.4 ft.)



- In conditions where the red-eye effect is likely to occur (low light conditions etc.), the red-eye reduction feature is activated when the shutter button is pressed halfway.

## C ② 閃光燈開啟模式

此模式下，無論照明度條件如何，閃光燈將每次都閃光。在白天拍攝一個逆光中的主體時，可利用此模式以便使照片的對比度顯得柔和些。

將模式轉盤推至 .

閃光燈有較距離（彩色膠片）

ISO 100	ISO 400
0.8 - 3.4 米 (2.6-11.2 呎)	0.8 - 6.8 米 (2.6-22.4 呎)



- 當半按下快門按鈕時，在可能發生紅眼現象的環境條件下（例如低照度條件等，將激活（打開）防紅眼功能。

## **M** ② Mod Lampu Pancaran Hidup/ON

Dalam mod ini, lampu pancaran akan beroperasi tanpa mengendahkan keadaan cahaya. Gunakan mod ini untuk melembutkan pertentangan itu apabila cahaya menerangi subjek dari belakang di waktu siang hari.

**Tukar dail mod ke  $\downarrow$ .**

**Julat jarak lampu pancaran (dengan filem cetakan warna)**

ISO 100	ISO 400
0.8 hingga 3.4 m (2.6 hingga 11.2 kaki)	0.8 hingga 6.8 m (2.6 hingga 22.4 kaki)



- Dalam keadaan di mana kesan mata merah kelihatan akan berlaku (keadaan cahaya kurang terang dan sebagainya), ciri pengurangan mata merah diaktifkan apabila butang pengatup ditekan separuh.

## **K** ② 플래시 ON 모드

이 모드에서는 조명조건에 관계없이 플래시가 작동합니다. 주간에 배경이 밝은 곳에서 촬영시에 피사체와의 콘트라스트를 줄이기 위해 사용합니다.

**모드 다이얼로  $\downarrow$  를 선택합니다.**

**플래시 거리 범위 (킬러필름 사용시)**

ISO 100	ISO 400
0.8 ~ 3.4 m (2.6 ~ 11.2 ft.)	0.8 ~ 6.8 m (2.6 ~ 22.4 ft.)



- 적목완화기능이 작동하는 촬영조건(어두운 장소 등)에서는 셔터 버튼을 반쯤 누른 상태에서 적목완화기능이 작동합니다.

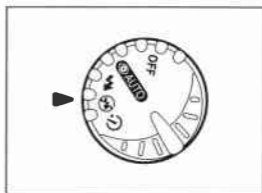

### **E** ③ Flash OFF Mode

Use this mode in locations where flash photography is prohibited or when you want to take pictures using only the available light.

Turn the mode dial to ③ .

### **C** ③ 閃光燈關閉模式

在禁用閃光燈拍照的地方，或利用現場的光線拍攝照片時，請利用此模式。

將模式轉盤推至 ③ 。

---

**M** ③ **Mod Lampu Pancaran Padam/OFF**

Gunakan mod ini di lokasi-lokasi di mana lampu pancaran fotografi dilarang atau sewaktu anda ingin melakukan penggambaran dengan hanya menggunakan cahaya yang tersedia sahaja.

**Tukar dail mod ke ④.**

---

**K** ③ **플래시 OFF 모드**

이 모드는 플래시 사용이 금지된 곳 또는 자연광으로만 촬영하고자 할 경우에 사용합니다.

모드 다이얼로 ④를 선택합니다.

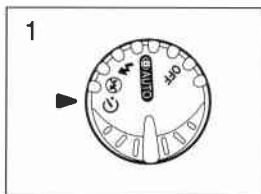

## **E** ④ Self-timer Mode

You can use the self-timer mode to include yourself in pictures by delaying the shutter release. Place the camera on a steady surface, or mount it in a tripod when using the self-timer mode.

1. Turn the mode dial to .
2. Place the center of the viewfinder over the subject.
3. The green indicator lights up when the shutter button is pressed and the self-timer starts.
  - The red-eye reduction lamp starts flashing and the shutter is released after approximately 10 seconds.

## **C** ④ 自拍器模式

可利用自拍模式延遲快門釋放時間而讓自己也照到照片中。但須把照相機放在平穩處或使用三腳架拍攝。

1. 將模式轉盤推至 .
2. 讓主體置於觀景窗的中央。
3. 當按下了快門，自拍器啟動時，綠色指示燈即點亮。
  - 當快門釋放約10秒後，防紅眼燈使開始閃亮。



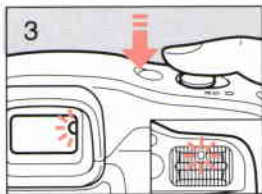
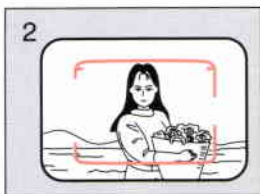

## **M** ④ Mod Pemasaan Diri

Anda boleh menggunakan mod pemasaan diri bagi memasukkan diri anda ke dalam gambar dengan melambatkan pembebasan butang pengatup. Letakkan kamera di atas permukaan yang mantap atau gunakan tripod.

1. Tukar dail mod kepada ☺ .
2. Pusatkan pемidang tilik ke atas subjek.
3. Penunjuk hijau menyala apabila butang pengatup ditekan dan pemasaan diri bermula.
  - Lampu pengurangan mata merah akan mula menyala dan butang pengatup dibebaskan selepas kira-kira 10 saat.

## **K** ④ 자동타이머 모드

자기 자신이 피사체에 포함되고자 하는 경우에는 자동 타이머로 셔터의 작동을 늦출 수 있습니다. 카메라를 안정된 물체 위나 삼각대에 고정하여 주십시오.

1. 모드 다이얼로 ☺를 선택합니다.
2. 뷰파인더의 중심에 피사체를 맞춥니다.
3. 셔터버튼을 누르면 녹색 지시계가 점등하고 자동타이머가 작동하기 시작합니다.
  - 적목완화램프가 깜빡거리기 시작하고 약 10초 후에 셔터가 작동합니다.

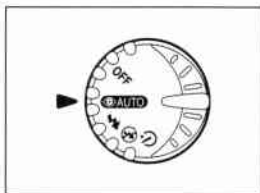

## **E** To cancel the self-timer

- Turn the mode dial to a different setting.



- Do not stand directly in front of the camera when you press the shutter button as this will set the focus incorrectly.



- For the last 2 seconds before the picture is taken, the red-eye reduction/self-timer lamp blinks rapidly. When the red-eye reduction function is operating, it lights continuously for the last 2 seconds before the picture is taken.

## **C** 取消自拍器模式

- 將模式轉盤推至其他設定即可。



- 當按下快門鈕時，切勿站在照相機的前面。因為會使對焦設定不準確。



- 在拍攝前的最後兩秒，防紅眼 / 自拍燈將加快閃爍。當防紅眼功能操作時，此燈將持續點亮至拍攝照片的2秒前。

## **M** Membatalkan pemasaan diri

- Tukar dail mod kepada penetapan yang berbeza.



- Jangan berdiri di depan kamera apabila anda menekan butang pengatup kerana ini akan menyebabkan kesalahan fokus berlaku.



- Untuk selama dua saat terakhir sebelum gambar diambil, lampu pengurangan mata merah akan berkelip dengan laju. Bila fungsi pengurangan mata merah beroperasi, ia menyala berterusan untuk 2 saat terakhir sebelum gambar diambil.

## **K** 자동타이머 모드를 취소하려면

- 모드 다이얼로 다른 모드를 선택합니다.



- 초점이 정확하게 맞지 않을 염려가 있으므로 셔터 버튼을 누른 후 카메라 앞에 서지 마십시오.



- 촬영하기 전의 2초 동안은 적목완화 램프/자동타이머 램프의 깜빡거림이 빨라집니다. 적목완화 기능이 작동하고 있는 경우는 촬영하기 전의 최후 2초 동안 점등된 상태를 유지합니다.

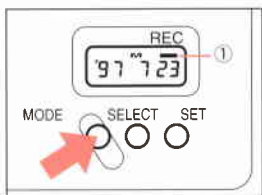

## E 9 Imprinting the Date and Time

Press the MODE button to select the date and time to be imprinted on the photograph. Each time the button is pressed, the selection changes as shown above.



- Use the projection on the strap fixture to press the buttons.
- When the shutter is released, the imprinting confirmation mark ① flashes to indicate that the date or time has been imprinted.
- If the background of the imprinting position is bright or includes an orange or white subject, the figures imprinted may be difficult to see. Positioning the imprinting over dark or black areas will make the figures easier to see.

## C 9 加印日期和時間

按下MODE 按鈕以選擇要加印在照片上的日期和時間。每次按下此按鈕，選擇即將作如上的變化。



- 請用背帶扣上的突起部分按下此按鈕。
- 快門釋放時，加印資料標誌 ① 起閃爍以表示已印上了日期和時間。
- 加印位置如果有光亮或含橙色或白色，則印在上面的數目字可能較難辨認。若加印在陰暗或黑色背景上將比較容易看得清楚。



## M 9 Mengecap Tarikh dan Masa

Tekan butang MODE untuk memilih tarikh dan masa yang hendak dicapkan di atas gambar. Setiap kali butang itu ditekan, pilihan akan berubah seperti yang ditunjukkan dibawah.



- Gunakan unjuran pada pengikat tali untuk menekan butang tersebut.
- Apabila pengatup dibebaskan, tanda pengesahan pengecapan ① menyala bagi menandakan tarikh atau masa telah dicapkan.
- Jika latarbelakang kedudukan pengecapan itu adalah terang atau terdapat satu subjek berwarna oren atau putih, angka yang dicap itu mungkin sukar untuk dilihat. Letakkan pengecapan itu di atas kawasan gelap atau hitam supaya membuatkan angka itu mudah untuk dilihat.

## K 9 날짜 및 시간 입력

MODE 버튼을 눌러 날짜 및 시간을 선택하여 사진에 입력할 수 있습니다. 버튼을 누를 때마다 위에서 보는 바와 같이 선택이 바뀝니다.



- 손잡이 고정쇠의 돌기부로 버튼을 눌러 주십시오.
- 셔터가 작동할 때 촬영확인 마크 ①이 깜빡이며 날짜 또는 시각이 프린트 되는 것을 나타냅니다.
- 만약 입력위치의 배경이 밝거나 오렌지 또는 흰색의 피사체인 경우에는 입력문자가 잘 보이지 않습니다. 따라서 어둡거나 검은 배경 위로 입력위치를 선택하면 보다 잘 보입니다.

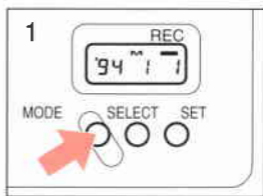

## E 10 Setting the Date

The camera has a built-in automatic calendar that runs until the year 2019, so there is no need to set the date each time pictures are taken. However, the procedure below describes how to correct the date when you are traveling overseas or have replaced the battery.

### 1. Press the **MODE** button.

- Display the date format to be corrected.

### 2. Press the **SELECT** button.

- Press until the digit to be corrected blinks.

### 3. Press the **SET** button.

- Correct the digit.

## C 10 設定日期

本照相機內置至2019年的自動日曆。每次拍照無需重新設定日期。當您外出旅行，或更換電池時，便須根據下列方法更正日期。

### 1. 按下 **MODE** 按鈕。

- 顯示要校正的日期格式。

### 2. 按下 **SELECT** 按鈕。

- 按至需調節位置上的數字開始閃動。

### 3. 按下 **SET (設定)** 按鈕。

- 設定所需數字。

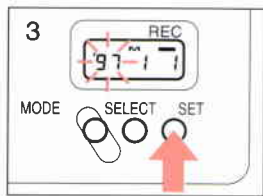
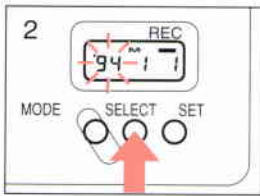

## M 10 Penetapan Tarikh

Kamera ini mempunyai kalendar bina dalam automatik yang akan beroperasi sehingga tahun 2019, maka adalah tidak perlu untuk menyetek tarikh setiap kali gambar diambil. Walau bagaimana pun, prosedur di bawah menerangkan tentang bagaimana untuk membetulkan tarikh apabila anda melancong ke luar negeri atau sewaktu menggantikan bateri.

### 1. Tekan butang MODE.

- Memaparkan format tarikh untuk diperbetulkan.

### 2. Tekan butang SELECT.

- Tekan sehingga angka yang hendak diperbetulkan berkelip.

### 3. Tekan butang SET.

- Betulkan angka tersebut.

## K 10 날짜 세팅

본 카메라에는 서기 2019년까지 작동하는 자동캘린더가 내장되어 있으므로 촬영할 때마다 날짜를 세팅할 필요가 없습니다.

### 1. MODE 버튼을 누릅니다.

- 적당한 날짜 구성을 디스플레이합니다.

### 2. SELECT 버튼을 누릅니다.

- 적당한 숫자가 깜빡거릴 때까지 누릅니다.

### 3. SET 버튼을 누릅니다.

- 숫자를 수정합니다.

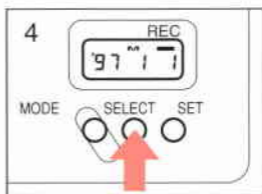

#### **E** 4. Press the SELECT button until all digits stop blinking.

- When all the digits are lit, no longer blinking, the setting is complete.



- The automatic calendar will not work correctly if only the date has been set. Always set the time as well.



- Pressing the SET button once moves to the next digit. Hold the SET button down to move through the digits in succession.
- Use the projection on the strap fixture to press the buttons.

#### **C** 4. 按下 SELECT 按鈕直到。

- 所有的數字都點亮了，便不再閃爍，設定即告完成。



- 如果您只設定好日期而已，自動日曆便將不能正確地起作用。務請也設定好時間。



- 每按一次 SET 按鈕，數值會加一。當按住 SET 按鈕時，數字便快速遞增。
- 請用背帶扣上的突起部分。



#### **M** 4. Tekan tombol SELECT sehingga semua angka berhenti berkelip.

- Apabila semua angka menyala, dan tidak lagi berkelip, penetapan tersebut adalah lengkap.



- Kalender otomatis tidak akan berfungsi dengan betul jika hanya tarikh sahaja yang disetkan. Sentiasa setkan masa juga.



- Tekan tombol SET sekali untuk bertukar ke angka selanjutnya. Biarkan tombol SET ditekan bagi menggerakkan angka-angka secara berterusan.
- Gunakan unjuran pada pengikat tali untuk menekan tombol tersebut.

#### **K** 4. 모든 숫자의 깜빡거림이 정지될 때까지 SELECT 버튼을 누릅니다.

- 모든 숫자의 깜빡임이 정지하고 점등 상태가 되면 설정이 완료된 것입니다.



- 날짜만 세트되어 있으면 자동캘린더는 바르게 작동하지 않습니다. 반드시 시각도 세트해 주십시오.



- SET 버튼을 한 번 누르면 다음 숫자로 넘어갑니다. SET 버튼을 누른채로 있으면 숫자가 연속적으로 진행합니다.
- 손잡이 고정쇠의 돌기부를 사용해 주십시오.

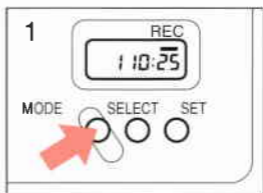

## E 11 Setting the Time

The camera has a built-in automatic calendar that runs until the year 2019, so there is no need to set the time each time pictures are taken. However, the procedure below describes how to correct the time when you are traveling overseas or have replaced the battery.

### 1. Press the MODE button.

- Display the time format to be corrected.

### 2. Press the SELECT button.

- Press until the digit to be corrected blinks.

### 3. Press the SET button.

- Correct the digit.

## C 11 設定時間

本照相機內置至2019年的自動日曆。每次拍照無需重新設定時間。當您外出旅行，或更換電池時，便須根據下列方法更正時間。

### 1. 按下 MODE 按鈕。

- 顯示要校正的時間格式。

### 2. 按下 SELECT 按鈕。

- 按至需調節位置上的數字開始閃動。

### 3. 按下 SET (設定) 按鈕。

- 設定所需數字。

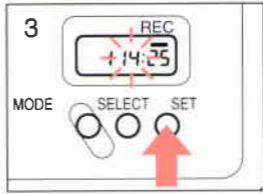
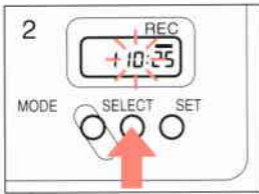

## M 11 Penetapan Masa

Kamera ini mempunyai kalender bina dalam automatik yang akan beroperasi sehingga tahun 2019, maka adalah tidak perlu untuk menyetek masa setiap kali gambar diambil. Walau bagaimana pun, prosedur di bawah menerangkan tentang bagaimana untuk membetulkan masa apabila anda melancong ke luar negeri atau sewaktu menggantikan bateri.

### 1. Tekan butang MODE.

- Memaparkan format masa untuk diperbetulkan.

### 2. Tekan butang SELECT.

- Tekan sehingga angka yang hendak diperbetulkan berkelip.

### 3. Tekan butang SET.

- Betulkan angka tersebut.

## K 11 시간 세팅

본 카메라에는 서기 2019년까지 작동하는 자동캘린더가 내장되어 있으므로 촬영할 때마다 시각을 세트할 필요가 없습니다.

### 1. MODE 버튼을 누릅니다.

- 적당한 시간 구성을 디스플레이합니다.

### 2. SELECT 버튼을 누릅니다.

- 적당한 숫자가 깜빡거릴 때까지 누릅니다.

### 3. SET 버튼을 누릅니다.

- 숫자를 수정합니다.

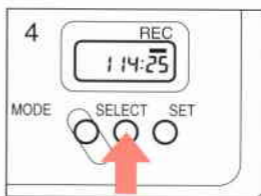

#### **E** 4. Press the **SELECT** button until all digits stop blinking.

- When all the digits are lit, no longer blinking, the setting is complete.



- Pressing the SET button once moves to the next digit. Hold the SET button down to move through the digits in succession.
- Use the projection on the strap fixture to press the buttons.

### Replacing the Date Battery

When the digits imprinted on photographs become faint regardless of the background, replace the date battery. One CR2025 lithium battery is used to maintain the date.

#### **C** 4. 按下 **SELECT** 按鈕直到。

- 所有的數字都點亮了，便不再閃爍，設定即告完成。



- 每按一次 SET 按鈕，數值會加一。當按住 SET 按鈕時，數字便快速遞增。
- 請用背帶扣上的突起部分。

### 更換日期用電池

加印在照片上的數字，無論背景如何都顯得模糊不清時，請更換日期用電池。

本相機使用 1 顆 CR2025 鋰電池以維持日期的顯示。

#### **M** 4. Tekan tombol SELECT sehingga semua angka berhenti berkelip.

- Apabila semua angka menyala, dan tidak lagi berkelip, penetapan tersebut adalah lengkap.



- Tekan tombol SET sekali untuk bertukar ke angka selanjutnya. Biarkan tombol SET ditekan bagi menggerakkan angka-angka secara berurutan.
- Gunakan unjuran pada pengikat tali untuk menekan tombol tersebut.

#### **Mengantikan baterai tarikh**

Apabila angka yang dicapkan di atas gambar menjadi semakin kabur tanpa mengendahkan latar belakang, gantikan baterai tarikh tersebut. Sebiji bateri lithium CR2025 digunakan untuk mengekalkan tarikh berkenaan.

#### **K** 4. 모든 숫자의 깜빡거림이 정지될 때까지 SELECT 버튼을 누릅니다.

- 모든 숫자의 깜빡임이 정지하고 점등 상태가 되면 설정이 완료된 것입니다.



- SET 버튼을 한 번 누르면 다음 숫자로 넘어갑니다. SET 버튼을 누른채로 있으면 숫자가 연속적으로 진행합니다.
- 손잡이 고정쇠의 돌기부를 사용해 주십시오.

#### **날짜배터리 교환**

사진에 프린트되는 숫자가 배경과 관계없이 흐려지면 배터리를 교환해 주십시오. 날짜의 백업에는 CR2025 리튬 배터리 1개를 사용합니다.

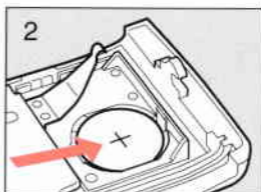
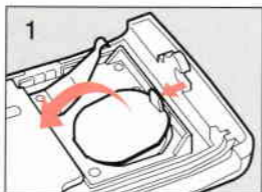

- E**
1. Open the back cover and flip up the date battery cover.
  2. Remove the battery and insert a new battery with the positive (+) terminal upwards.
  3. Close the date battery cover, then close the back cover.
  4. Readjust to the correct date/time.



- When you replace the date battery, the date shown on the date display changes. Set the correct date and time.
- Ensure that the battery is kept out of the reach of small children.

- C**
1. 打開照相機背蓋翻開日期用電池蓋。
  2. 取出電池並裝上新電池，把 (+) 電極面朝上方。
  3. 關上日期用電池蓋，然後關上背蓋。
  4. 重新調整以校正日期／時間。



- 當更換日期用電池時，日期顯示上的日期將起變化。請再對準日期和時間。
- 電池必須存放在遠離兒童的地方。

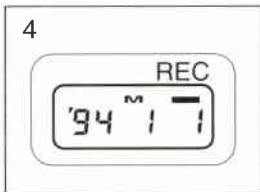
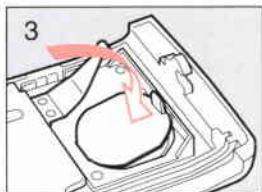

- M**
1. Buka penutup belakang dan tolak penutup bateri tarikh.
  2. Keluarkan bateri tersebut dan masukkan sebiji bateri dengan terminal positif (+) menghala ke atas.
  3. Tutup penutup bateri tarikh, kemudian tutup penutup belakang.
  4. Sila ubahsuaikan semula tarikh/masa yang betul.



- Apabila anda menggantikan bateri tarikh, tarikh yang ditunjukkan di paparan tarikh akan berubah. Setkan tarikh dan masa yang betul.
- Pastikan bateri itu dijauhi dari kanak-kanak.

- K**
1. 백커버를 열고 날짜배터리 커버를 엽니다.
  2. 배터리를 빼내고 새 배터리를 정 (+)극을 위로 해서 넣습니다.
  3. 우선 날짜배터리 커버를 닫고 백커버를 닫습니다.
  4. 바른 날짜/시각으로 다시 세트합니다.



- 날짜 세트를용 배터리를 교환하면 날짜디스플레이상의 날짜가 바뀝니다. 바른 날짜 및 시각을 다시 세트해 주십시오.
- 배터리는 아이들의 손이 닿는 곳에 두지 마십시오.

## **E** Troubleshooting

In case of trouble check the table below before taking you camera to be repaired.

<b>Problem</b>	<b>Cause</b>	<b>Remedy</b>	<b>Page</b>
Green indicator does not light up.	•The lens cover is not completely open.	•Turn the mode dial to <b>ⓈAUTO</b> .	38
	•No battery is loaded.	•Load the batteries.	16
	•The batteries are inserted with the wrong polarities.	•Reinsert the batteries correctly.	16
	•The batteries have completely expired.	•Replace the new batteries.	16
The shutter does not release.	•The lens cover is not completely open.	•Turn the mode dial to <b>ⓈAUTO</b> .	38
	•The power is turned off.	•Turn the power on.	16
	•The batteries are expired.	•Replace the new batteries.	16
	•A rewind film is loaded in the camera.	•Remove the film and load a new one.	34, 20
	•The film is not loaded properly.	•Reload the film.	20
The photographs are blurred.	•When the shutter was released, the AF light emitter/receptor were blocked.	•Ensure that the AF light emitter/receptor are not blocked by hair, fingers, etc.	24
	•In self-timer mode, you stood immediately in front of the camera when pressing the shutter button.	•Make sure you do not stand immediately in front of the camera when pressing the shutter button.	50
	•The camera moved when the shutter button was pressed (camera shake).	•Hold the camera firmly and gently press the shutter button.	28
The entire picture appears cloudy.	•The lens is dirty.	•Wipe the lens with a lens cloth.	—



## C 簡易故障解除方法

照相機送修前，請先參考下表。

故障	可能原因	解除方法	頁數
綠色指示燈不亮。	<ul style="list-style-type: none"> <li>鏡頭蓋沒有完全打開。</li> <li>沒有裝電池。</li> <li>電池裝錯了電極。</li> <li>電池完全耗完了電力。</li> </ul>	將模式度盤旋轉到 <b>ⓂAUTO</b> 。	38
		裝上電池。	16
		重新裝妥電池。	16
		更換新電池。	16
快門不釋放。	<ul style="list-style-type: none"> <li>鏡頭蓋沒有完全打開。</li> <li>電源關掉了。</li> <li>電池完全耗完了電力。</li> <li>已回捲的膠卷仍放在照相機內。</li> <li>膠卷沒裝妥當。</li> </ul>	將模式度盤旋轉到 <b>ⓂAUTO</b> 。	38
		開啟電源。	16
		更換新電池。	16
		取出膠卷裝上新膠卷。	34, 20
照片模糊。	<ul style="list-style-type: none"> <li>快門釋放時，AF(自動對焦)投光器和受光器被遮蓋。</li> <li>自拍器模式下，當您按下快門鈕時，正站在照相機的前面。</li> <li>當您按下快門按鈕時，相機幌動了(照相機幌動)。</li> </ul>	確認AF投光器/受光器沒有被自己頭髮、手指等遮蓋。	24
		按快門時，須注意別站在照相機前面。	50
		拿穩照相機並和緩地按下快門按鈕。	28
整張照片顯得模糊不清。	<ul style="list-style-type: none"> <li>鏡頭上有髒東西。</li> </ul>	<ul style="list-style-type: none"> <li>用鏡頭清潔布擦拭干淨。</li> </ul>	-

## M Penyelesaian Masalah

Dalam kes terdapatnya masalah, sila periksa jadual di bawah sebelum membawa kamera anda untuk diperbaiki.

Masalah	Sebab	Pembaikan	Muka Surat
Penunjuk hijau tidak menyala	• Penutup lensa tidak dibuka sepenuhnya.	• Tukarkan mod dail kepada  AUTO.	39
	• Tiada bateri dimasukkan.	• Masukkan bateri.	17
	• Bateri dimasukkan dengan kutub yang salah.	• Masukkan semula bateri dengan betul.	17
	• Bateri telah tamat hayat sepenuhnya.	• Gantikan dengan bateri baru.	17
Pengatup tidak terbebas.	• Penutup lensa tidak dibuka sepenuhnya.	• Tukarkan mod dail kepada  AUTO.	39
	• Kuasa dipadamkan.	• Hidupkan kuasa.	17
	• Bateri tamat hayat.	• Gantikan dengan bateri baru.	17
	• Filem yang telah digulung semula berada di dalam kamera.	• Keluarkan filem tersebut dan masukkan filem baru.	35, 21
Gambar-gambar adalah kabur.	• Filem tidak dimasukkan dengan betul.	• Masukkan semula filem.	21
	• Bila pengatup dibebaskan, penerima dan pemancar lampu AF telah dihalang.	• Pastikan penerima dan pemancar lampu AF tidak dihalang oleh rambut, jari dan sebagainya.	25
	• Dalam mod pemasaan diri, anda berdiri hampir dengan depan kamera semasa menekan butang pengatup.	• Pastikan diri anda tidak berdiri hampir di depan kamera semasa menekan butang pengatup.	51
Keseluruhan gambar kelihatan kelim.	• Kamera telah bergerak semasa butang pengatup ditekan. (Kamera bergoyang).	• Pegang kamera dengan mantap dan tekan butang pengatup dengan lembut.	29
	• Lensa kamera kotor.	• Lap lensa kamera dengan kain lensa yang lembut.	—

## K 촬영 트러블

트러블이 발생한 경우에는 카메라의 수리를 의뢰하기 전에 아래표의 내용을 체크해 주십시오.

트러블	원인	처치	페이지
녹색 지시계가 점등하지 않는다.	<ul style="list-style-type: none"> <li>•렌즈커버가 완전히 닫혀있지 않다.</li> <li>•배터리가 충전되어 있지 않다.</li> <li>•배터리의 전극이 바르게 충전되어 있지 않다.</li> <li>•배터리가 완전히 떨어졌다.</li> </ul>	<ul style="list-style-type: none"> <li>•모드 다이얼로 <b>● AUTO</b> 를 선택한다.</li> <li>•배터리를 충전한다.</li> <li>•배터리의 전극을 바르게 다시 충전한다.</li> <li>•새 배터리로 교환한다.</li> </ul>	39 17 17 17
셔터가 작동하지 않는다.	<ul style="list-style-type: none"> <li>•렌즈커버가 완전히 닫혀있지 않다.</li> <li>•전원이 꺼져있다.</li> <li>•배터리가 떨어졌다.</li> <li>•되감기된 필름 카트리지가 장착되어 있다.</li> <li>•필름 카트리지가 바르게 장착되어 있지 않다.</li> </ul>	<ul style="list-style-type: none"> <li>•모드 다이얼로 <b>● AUTO</b> 를 선택한다.</li> <li>•전원을 넣는다.</li> <li>•새 배터리로 교환한다.</li> <li>•필름 카트리지를 빼내고 새 것으로 장착한다.</li> <li>•필름을 다시 장착한다.</li> </ul>	39 17 17 35, 21 21
사진이 선명하지 않다.	<ul style="list-style-type: none"> <li>•셔터가 작동할 때 AF 라이트 발광기/센서가 가려졌다.</li> <li>•자동타이머 모드에서 셔터 버튼 작동 직전에 카메라 앞에 포즈를 취했다.</li> <li>•셔터버튼을 누른 후에 카메라가 움직였다(카메라 흔들림).</li> </ul>	<ul style="list-style-type: none"> <li>•AF 라이트 발광기/센서가 머리카락, 손가락 등에 가리지 않도록 주의한다.</li> <li>•미터 버튼이 작동되기 직전에 카메라 앞에 포즈를 취하지 않도록 한다.</li> <li>•카메라를 단단히 잡고 셔터 버튼을 부드럽게 누른다.</li> </ul>	25 51 29
사진이 전체적으로 흐리다.	<ul style="list-style-type: none"> <li>•렌즈가 더러워졌다.</li> </ul>	<ul style="list-style-type: none"> <li>•렌즈용 천으로 렌즈를 닦는다.</li> </ul>	-

## **E** Specifications

**Type:** 35mm fully automatic lens-shutter AF camera

**Display Size:** 24 × 36mm

**Lens:** Canon 35mm f/4.5

**Shooting Distance Range:** 0.8m/2.6ft. to infinity

**Shutter:** Shutter with combinable programs

**Viewfinder:** Inverted Galilean finder

**Loading:** Automatic (automatic blank film advance)

**Film Advance:** Automatic, mid-roll rewind possible

**Frame Counter:** Counts up during film winding and counts down during rewinding

**Film Check:** Film check window at back of the camera

**Film Speed Setting:** DX-coded film automatically set to ISO 100 or 400

**Self-timer:** Electronically-controlled 10 second delay timer activated by pressing the shutter button. The red-eye reduction/self-timer lamp blinks during operation.

### **Metering Range: (at ISO 100)**

Flash AUTO/Flash ON mode:

approx. 1/100 f/4.5 – approx. 1/180 f/11 (approx. EV10–16)

Flash OFF mode:

approx. 1/45 f/4.5 – approx. 1/180 f/11 (approx. EV10–16)

**Built-in Flash:** Built-in flash, automatically flashes in low light; Forced ON/OFF possible; Coupled with red-eye reduction lamp

**Flash Shooting Distance Range:** ISO 100: 0.8–3.4m (2.6–11.2ft.)  
ISO 400: 0.8–6.8m (2.6–22.4ft.)

**Flash Recycling Time:** Approx. 5 sec.

**Power Supply:** Uses two LR6 AA-size batteries, Ni-Cd or lithium AA-size batteries cannot be used

**Shooting Capacity:** Approx. 50 rolls of 24-exp. film (50% flash use) with AA manganese alkaline batteries

### **Dimensions:**

with date back: 125 (W) × 73 (H) × 50.2 (D) mm  
4-29/32 × 2-29/32 × 2 in.

without date back: 125 (W) × 73 (H) × 46.5 (D) mm  
4-29/32 × 2-29/32 × 1-13/16 in.

**Weight:** with date back: 230 g/8.1 oz; without date back: 220 g/7.8 oz (not including battery)

### **Imprinting Function :**

Method: LCD panel, auto-calendar with built-in quartz digital clock (automatic correction for leap years)

Imprinted Data: ① Year/Month/Day; ② Day/Hour/Minute;

③ No data imprinted; ④ Month/Day/Year; ⑤ Day/Month/Year

Imprinting Color: Orange

Power Supply: One lithium battery (CR2025)

- All data are based on Canon's Standard Test Method.
- Subject to change without notice.

## C 規格

**型式：**35mm 全自動鏡頭式快門 AF（自動對焦）照相機

**底片顯示尺寸：**24 × 36 mm

**鏡頭：**Canon 佳能 35mm f/4.5

**拍攝距離範圍：**0.8 米（2.6 呎）至無限遠。

**快門：**可組合程序的快門

**觀景窗：**倒相伽利略取景器

**裝片：**自動（自動膠卷片頭前捲）

**回片：**膠卷用自動回捲，亦可中途回捲。

**格數計算器：**向前捲片時，自動累加，回捲時自動遞減。

**檢視膠卷：**照相機背面的膠卷檢查窗

**膠片感光度設定：**DX 編碼膠卷可自動設定為 ISO 100 或 400

**自拍器：**按下快門鈕，電子控制的 10 秒延遲計時器便啟動，操作時，防紅眼 / 自拍器燈將會閃爍。

**測光範圍：（ISO 100 時）**

閃光燈 AUTO（自動） / 閃光燈 ON（開啟）模式：

約 1/100 f/4.5-約 1/180 f/11（約 EV 10-16）

閃光燈 OFF 模式：

約 1/45 f/4.5-約 1/180 f/11（約 EV 10-16）

**內置閃光燈：**內置於照相機的閃光燈，在弱光下將自動閃亮，可強制 ON/OFF（開啟 / 關掉），結合防紅眼燈

**閃光燈拍攝距離範圍：**

ISO 100: 0.8-3.4 米（2.6-11.2 呎）

ISO 400: 0.8-6.8 米（2.6-22.4 呎）

**閃光燈回電時間：**約 5 秒

**電源：**使用兩顆 LR6 的 3 號電池，切勿使用鎳鎘或鋰電池

**拍攝能力：**使用 3 號鎳鎘電池時，約可拍攝 50 卷 24 格的膠卷（50% 使用閃光燈拍攝）

**尺寸：**

背面日期：125（寬）× 73（高）× 50.2（深）mm

無背面日期：125（寬）× 73（高）× 46.5（深）mm

**重量：**背面日期：230 g；無背面日期：220 g（不含電池）

**加印功能 ：**

方法：液晶顯示屏，內置石英數字時鐘的自動日曆（自動校正閏年）

加印數據：① 年、月、日 ② 日、時、分 ③ 不加印

④ 月、日、年 ⑤ 日、月、年

加印顏色：橙色

電源：1 顆鋰電池（CR 2025）

- 所有的數據都是基於 Canon's Standard Test Method（佳能標準測試方法）。
- 有所改變時，恕不另行奉告。

## **M** Spesifikasi

**Jenis:** Kamera pengatup lensa AF automatik penuh 35mm.

**Saiz Paparan:** 24 × 36mm

**Lensa:** Canon 35mm f/4.5

**Jarak Penggambaran:** 0.8m/2.6 kaki hingga infinity.

**Pengatup:** Pengatup dengan program boleh gabung.

**Pemidang Tilik:** Pemidang songsang Galilean.

**Kemasukkan Filem:** Automatik (kemaraan filem kosong automatik).

**Kemaraan Filem:** Automatik, penggulungan semula di pertengahan gulungan boleh dilakukan.

**Kaunter Bingkai:** Mengira ke angka besar sewaktu filem berputar dan mengira ke angka kecil sewaktu penggulungan semula.

**Pemeriksaan Filem:** Tingkap pemeriksaan filem di belakang kamera.

**Penetapan Kelajuan Filem:** Filem pengkodan DX disetkan secara automatik kepada ISO 100 atau 400.

**Pemasaan Diri:** Bersifat elektronik, mengawal masa lewat 10 saat yang digerakkan dengan menekan butang pengatup. Lampu pengurangan mata merah/pemasaan diri berkelip sewaktu beroperasi.

**Julat Pemeteran: (pada ISO 100)**

Mod Lampu Pancaran AUTO/Lampu Pancaran ON:

Bersamaan kira-kira 1/100 f/4.5 – bersamaan kira-kira 1/180 f/11 (bersamaan kira-kira EV10-16)

Mod Lampu Pancaran OFF:

Bersamaan kira-kira 1/45 f/4.5 – bersamaan kira-kira 1/180 f/11 (bersamaan kira-kira EV10-16)

**Lampu Pancaran Bina Dalam:** Lampu pancaran bina dalam, menyala secara automatik dalam cahaya kurang terang; Boleh dihidup dan dipadamkan; bersama dengan lampu pengurangan mata merah.

**Jarak Penggambaran Lampu Pancaran:** ISO 100: 0.8–3.4m (2.6 kaki–11.2 kaki)  
ISO 400: 0.8–6.8 m (2.6–22.4 kaki)

**Tempoh pusingan semula lampu pancaran:** Bersamaan kira-kira 5 saat.

**Bekalan Kuasa:** Menggunakan bateri LR6 bersaiz AA, bateri Ni-Cd atau lithium tidak boleh digunakan.

**Kapasiti Penggambaran:** Bersamaan dengan kira-kira 50 gulungan filem 24 dedahan (penggunaan 50% lampu pancaran) dengan bateri alkali mangan bersaiz AA.

**Dimensi:** Dengan tarikh di belakang: 125 (W) × 73 (H) × 50.2 (D) mm/

4-29/32 (W) × 2-29/32 (H) × 2 (D) inci

Tanpa tarikh di belakang: 125 (W) × 73 (H) × 46.5 (D) mm/

4-29/32 (W) × 2-29/32 (H) × 1-13/15 (D) inci

**Berat:** Dengan tarikh di belakang: 230 g/8.1 aun;

Tanpa tarikh di belakang: 220 g/7.8 aun (tidak termasuk bateri)

**Fungsi Pengecapan** **DATE** :

Kaedah: Panel LCD, kalendar automatik dengan jam digital quarza bina dalam (pembetulan automatik bagi tahun lompat).

Data Pengecapan: ① Tahun. Bulan. Hari. ② Hari. Jam. Minit. ③ Tiada data dicapkan. ④ Bulan. Hari. Tahun. ⑤ Hari. Bulan. Tahun.

Warna Pengecapan: Oren

Bekalan Kuasa: Satu bateri lithium (CR2025)

- Semua data berdasarkan kepada Kaedah Ujian Piawaian Canon.
- Tertukluk kepada pindaan tanpa notis.

## K 사양

타입: 35 mm 전자동 렌즈 셔터 AF 카메라

영상사이즈: 24 x 36 mm

렌즈: 캐논 35 mm f/4.5

촬영거리: 0.8 m (2.6 ft.)에서 무한대

셔터: 조합 프로그램 전자식 구동 셔터

뷰파인더: 반전 갈릴레이식 파인더

필름 장착: 자동(공 필름 자동 진행)

필름 감기: 자동, 촬영도중 되감기 가능

촬영매수 카운터: 촬영시 카운트 업, 되감기시 카운트 다운

필름 장착 확인: 백커버의 필름 창

필름 스피드 세트: DX코드 필름은 자동적으로 ISO 100 또는 400으로 세트

자동타이머: 셔터 버튼을 누르면 작동하는 전자제어식 10초 지연 타이머, 작동중에는 적목완화/자동 타이머 램프가 깜빡거림.

측정 범위(ISO 100):

플래시 AUTO/플래시 ON 모드:

약 1/100 f/4.5-약 1/180 f/11(약 EV10-16)

플래시 OFF 모드:

약 1/45 f/4.5-약 1/180 f/11(약 EV10-16)

내장플래시: 어두운 곳에서 자동으로 발광하는 내장플래시.

강제 ON/OFF가능, 적목완화램프와 연동

플래시범위: ISO 100: 0.8 - 3.4 m (2.6 - 11.2 ft.)

ISO 400: 0.8 - 6.8 m (2.6 - 22.4 ft.)

플래시 재충전 시간: 약 5초

전원: LR6 AA사이즈 배터리 2개, 니카드 또는 리튬 배터리는 사용불가

촬영 용량: AA 망간 알칼리 배터리 사용시에 24컷까지 촬영필름(플래시를 50% 사용) 약 50통

외형 치수:

데이트 백 포함: 125 (W) x 73 (H) x 50.2 (D) mm

4-29/32 x 2-29/32 x 2 in.

데이트 백 포함하지 않음: 125 (W) x 73 (H) x 46.5 (D) mm

4-29/32 x 2-29/32 x 1-13/16 in.

중량: 데이트 백 포함 230 g; 데이트 백 포함하지 않음 220 g (배터리는 제외)

날짜입력기능 **DATE** :

방법: LCD 판넬, 석영 디지털시계의 자동캘린더(윤년 자동 보정)

입력되는 날짜: ① 날짜 없음, ② 년월일, ③ 일시분, ④ 월 일년, ⑤ 일월년

입력색상: 오렌지

전원공급: 리튬배터리 1개(CR2025)

- 모든 데이터는 캐논 표준테스트법 기준임.
- 사양 및 외형은 사전 예고 없이 변경될 수 있음.

# Canon

**CANON INC.** 30-2, Shimomaruko 3-chome, Ohta-ku, Tokyo 146, Japan

**U.S.A. ——— CANON U.S.A. INC.**

For all inquiries concerning this camera, call toll free in the U.S.  
1-800-828-4040

or write to:

Customer Relations,

Canon U.S.A., Inc.

One Canon Plaza, Lake Success, N.Y. 11042-1113

**CANADA ——— CANON CANADA INC. HEADQUARTERS**

6390 Dixie Road, Mississauga, Ontario L5T 1P7, Canada

**CANON CANADA INC. MONTREAL BRANCH**

5990, Côte-de-Liesse, Montréal Québec H4T 1V7, Canada

**CANON CANADA INC. CALGARY OFFICE**

2828, 16th Street, N.E. Calgary, Alberta T2E 7K7, Canada

For all inquiries concerning this camera, call toll free in Canada  
1-800-828-4040

**EUROPE, ——— CANON EUROPA N.V.**

**AFRICA &**

**MIDDLE EAST**

Bovenkerkerweg 59-61, P.O. Box 2262, 1180 EG Amstelveen,  
The Netherlands

**CANON PHOTO VIDEO FRANCE S.A.**

11, Avenue Dubonnet Le Doublon 92407 Courbevoie Cedex, France

**CANON UK LTD.**

Brent Trading Centre, North Circular Road, London NW10 0JF,  
United Kingdom

**CANON EURO-PHOTO G. m. b. H.**

Siemensring 90-92, D-47877 Willich, Germany

**CANON ITALIA S.p.A.**

Via Meccenate 90, 20138 Milano, Italy

**CANON Benelux N.V./S.A.**

Bessenveldstraat 7, 1831 Diegem (Machelen), Belgium

**CANON Schweiz AG**

Geschäftsbereich Wiederverkauf, Industriestrasse 12, CH-8305  
Dietlikon, Switzerland

**CANON G. m. b. H.**

Oberlaaerstrasse 233, 4th floor, 1100 Wien, Austria

**CENTRAL & ——— CANON LATIN AMERICA, INC. DEPTO DE VENTAS**

**SOUTH AMERICA**

6505 Blue Lagoon Drive, Suite 325, Miami, FL33126 U.S.A.

**CANON LATIN AMERICA, INC. CENTRO DE SERVICIO Y  
REPARACION**

Apartado 2019, Zona Libre de Colón, República de Panamá

**ASIA ——— CANON SINGAPORE PTE. LTD.**

79 Anson Road #09-01/06 Singapore 079906

**OCEANIA ——— CANON AUSTRALIA PTY. LTD.**

1 Thomas Holt Drive North Ryde, N.S.W. 2113, Australia

**CANON NEW ZEALAND LTD.**

Fred Thomas Drive, P.O. Box 33-336, Takapuna, Auckland, New Zealand

**JAPAN ——— CANON SALES CO., INC.**

12-15 Mita, 3-Chome, Minato-ku, Tokyo 108, Japan